

**WH3Q-DS-2G13-8-
-LAWETA-5
(MERCEDES SPRINTER)
WH3B**

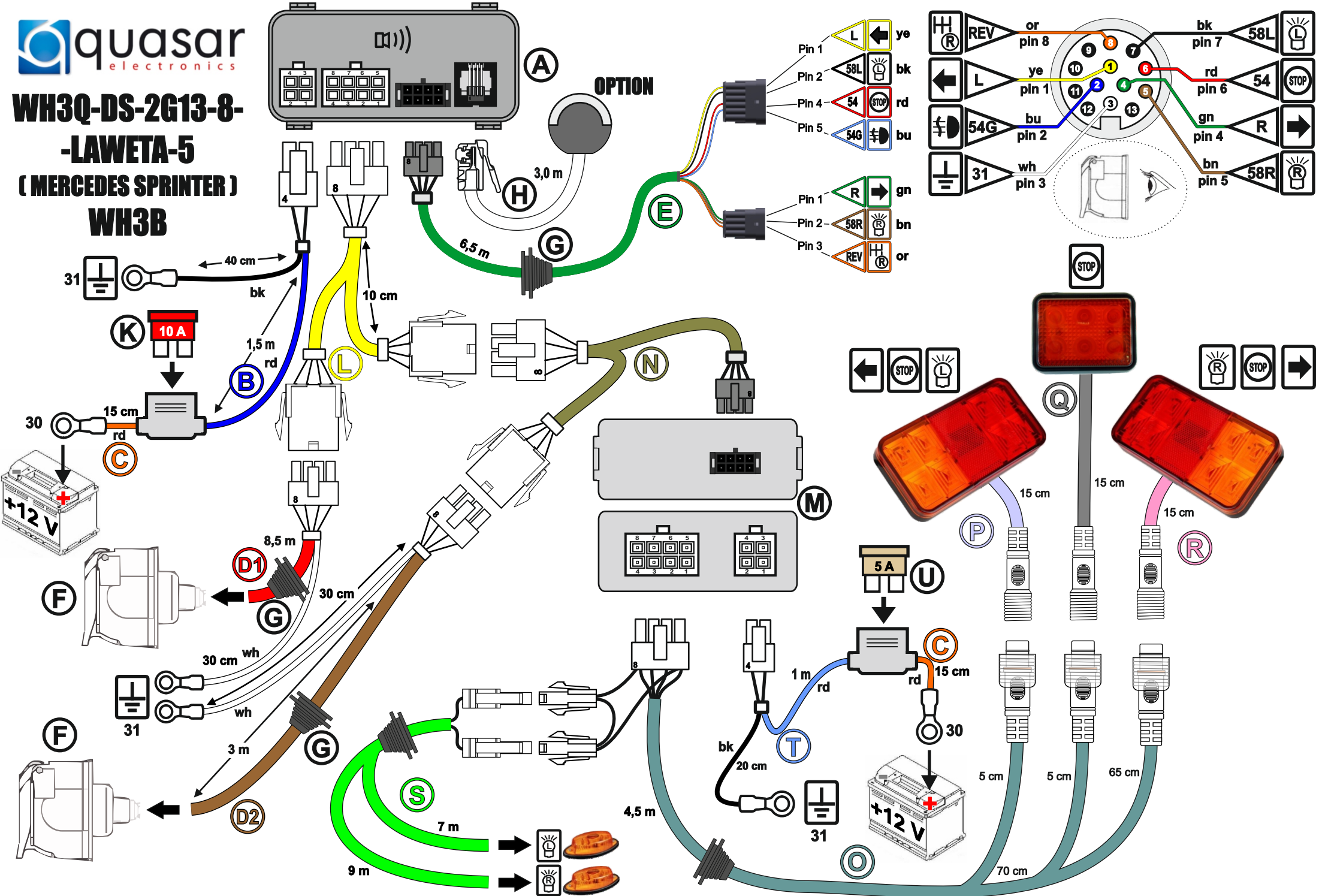

WH3Q-2G13-8-LAWETA-5-SPRINTER

Typ zabudowy:	LAWETA
Miejsce montażu:	KABINA-5
Wersja okablowania:	SPRINTER

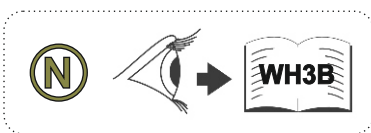
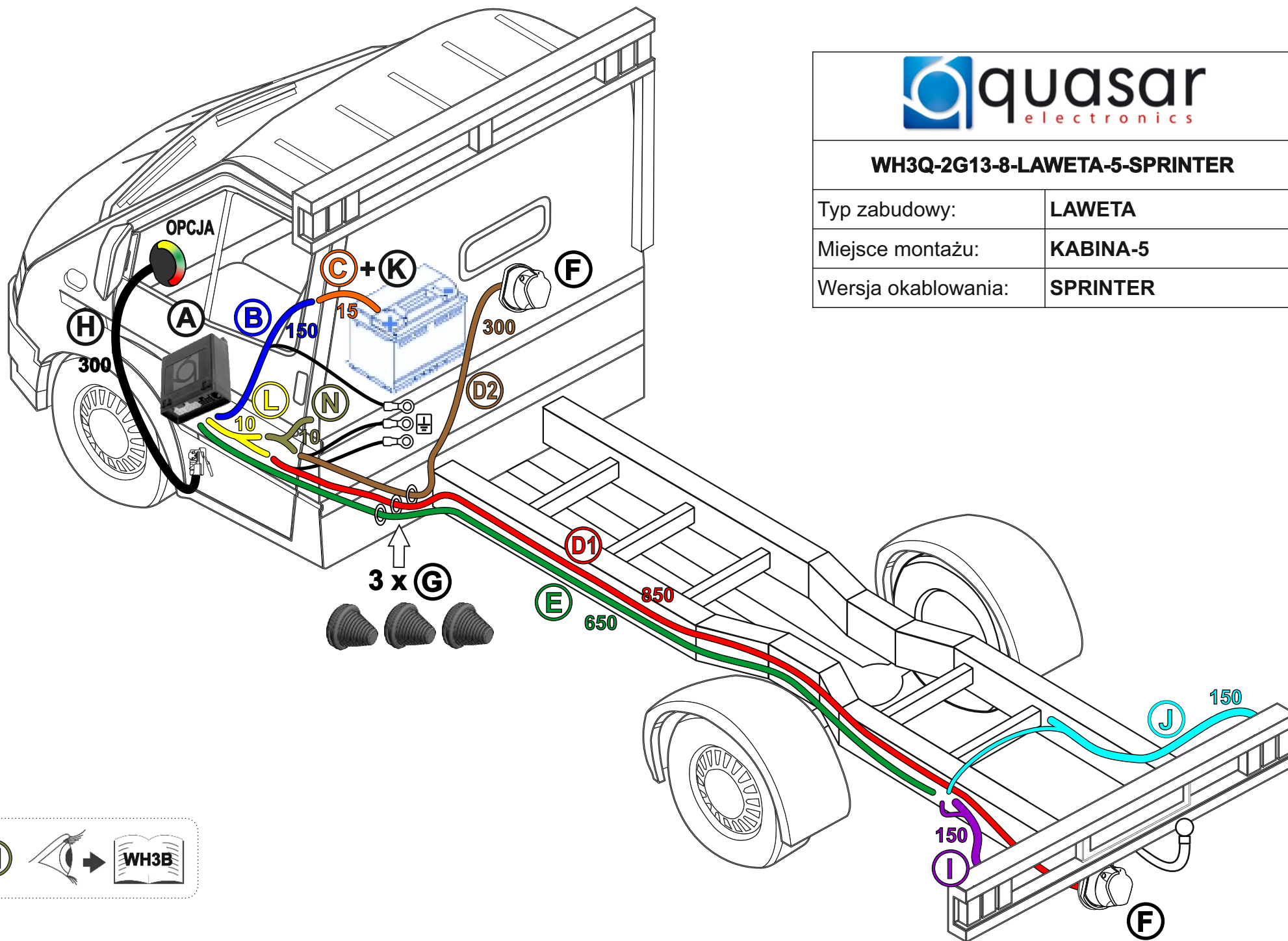



WH3Q-DS
moduł sterujący

(A)

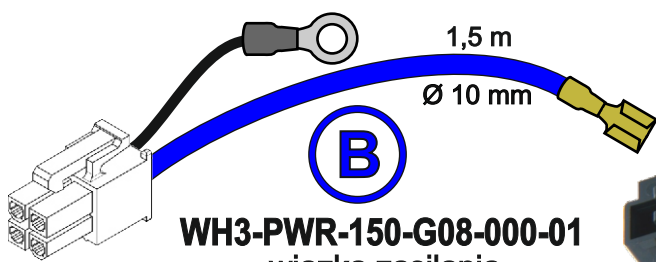

WH3-PWR-150-G08-000-01
wiązka zasilania

(B)

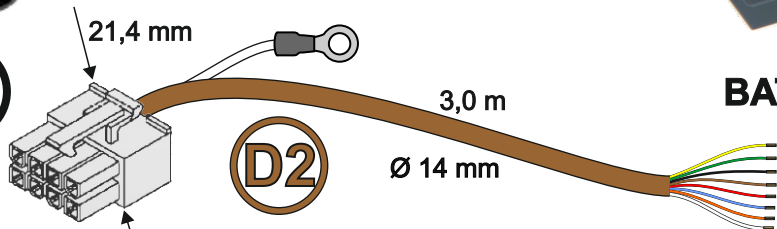

WH3-OUT-300-G08-P14-01
wiązka przedniego gniazda haka

(D2)

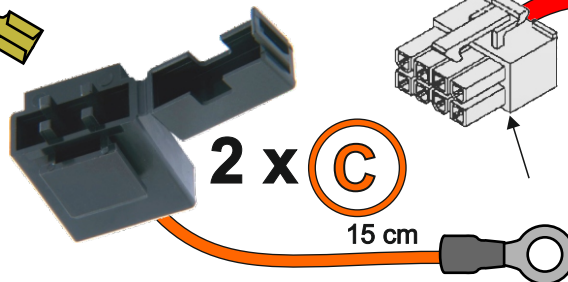

BAT-FSE-015-G08-CLR-01
wiązka bezpiecznika

2 x (C)

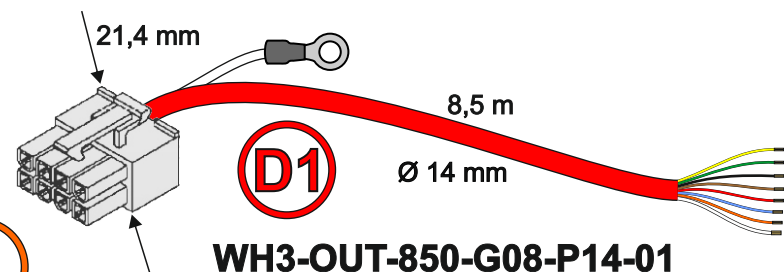

WH3-OUT-850-G08-P14-01
wiązka tylnego gniazda haka

(D1)



G13
gniazdo haka z uszczelką

2 x (F)



462040
dławnica schodkowa 21 mm

3 x (G)

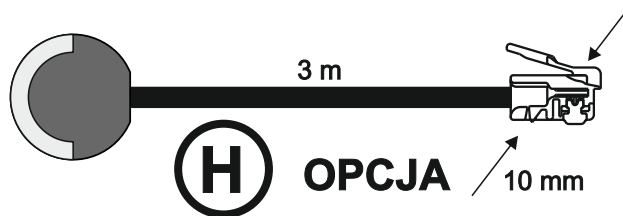

LED-RGY-300-R09-CLR-01
3-kolorowa dioda sygnalizacyjna

(H)

3 m

OPCJA

10 mm

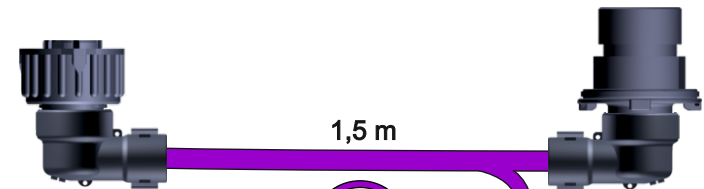

WH3-INP-650-P2P-P10-01
wiązka sygnałów wejściowych P2P

(E)

6,5 m

Ø 10 mm



Bezpiecznik 10 A

(K)

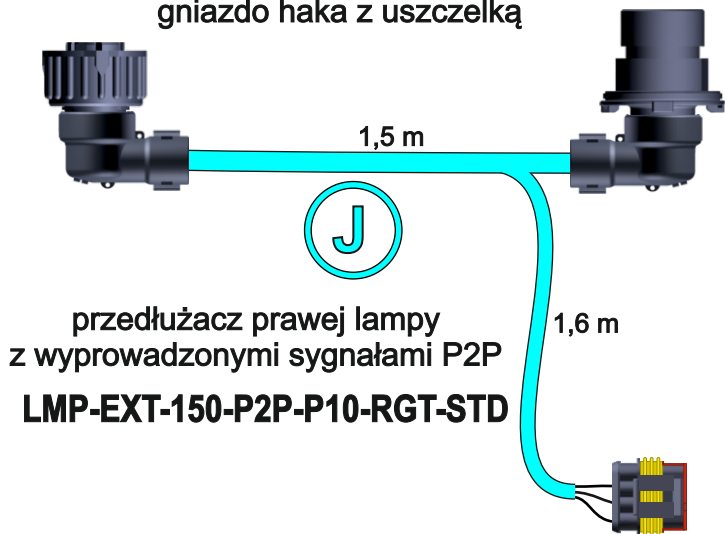

przedłużacz prawej lampy
z wyprowadzonymi sygnałami P2P
LMP-EXT-150-P2P-P10-RGT-STD

(J)

1,5 m

1,6 m

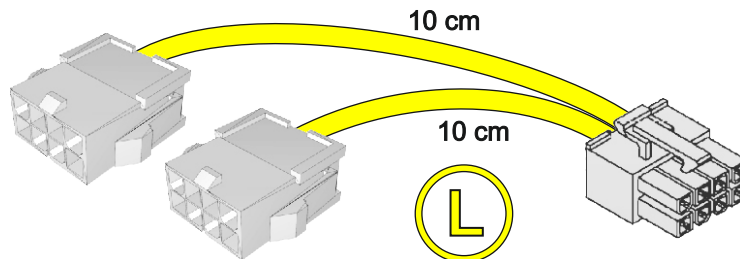

WH3-SPR-010-1T2-CLR-01
Wewnętrzny rozgałęziacz gniazd haka

(L)

10 cm

10 cm

LMP-EXT-150-P2P-P10-LFT-STD
przedłużacz lewej lampy
z wyprowadzonymi sygnałami P2P

(I)

1,5 m

10 cm



WH3Q-G13-8-LAWETA-5-P2P-SPRINTER

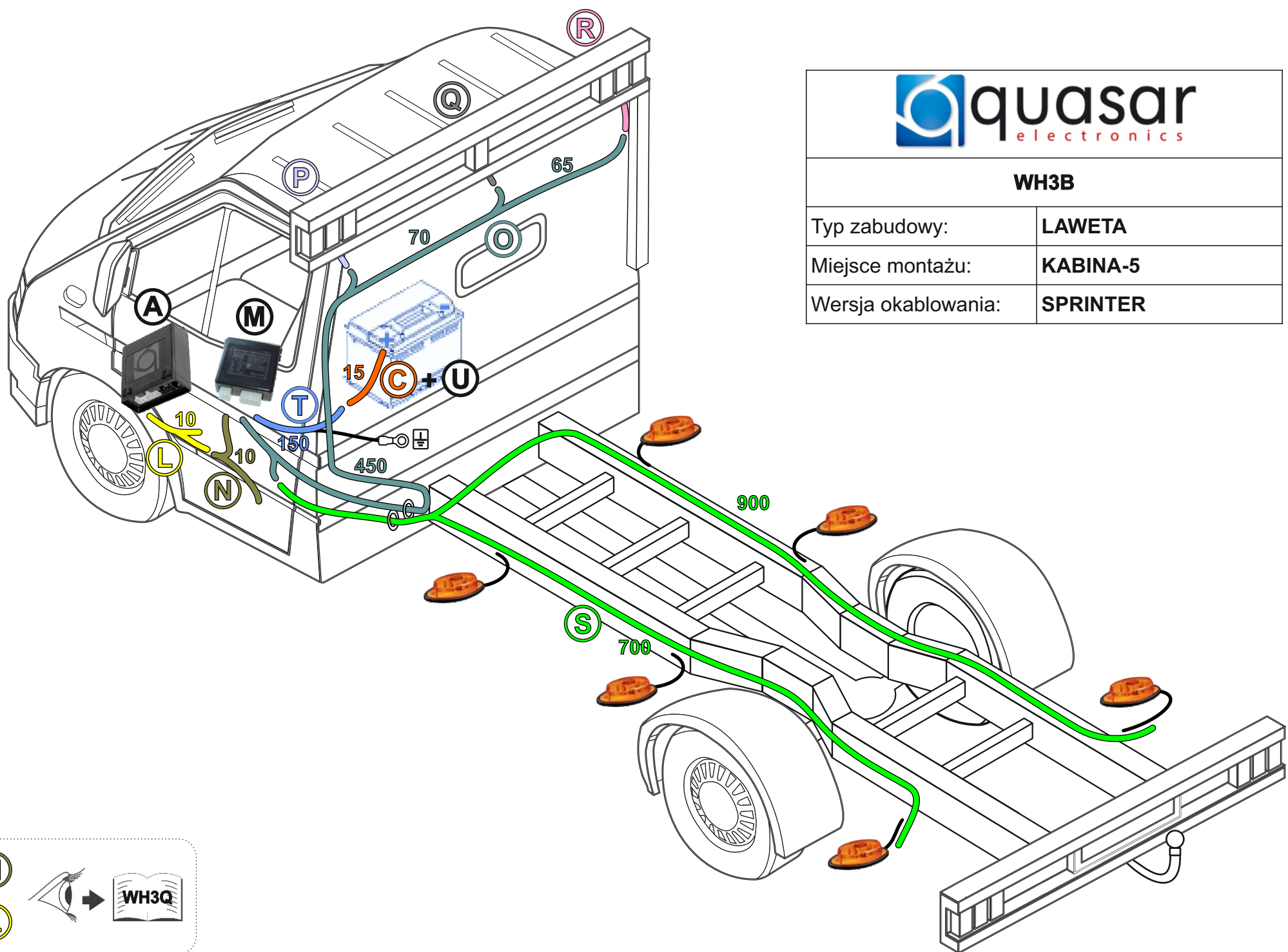

WH3B

Typ zabudowy:	LAWETA
Miejsce montażu:	KABINA-5
Wersja okablowania:	SPRINTER

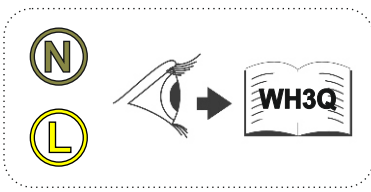



M

WH3B
moduł sterujący
lampami belki

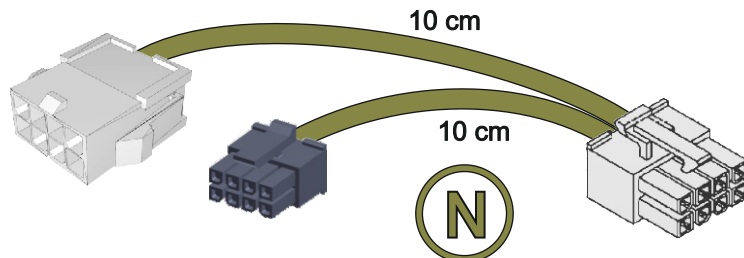

WH3B-SPR-020-1T2-CLR-01
Wewnętrzny rozgałęziacz sygnału wyjściowego

10 cm

10 cm

N

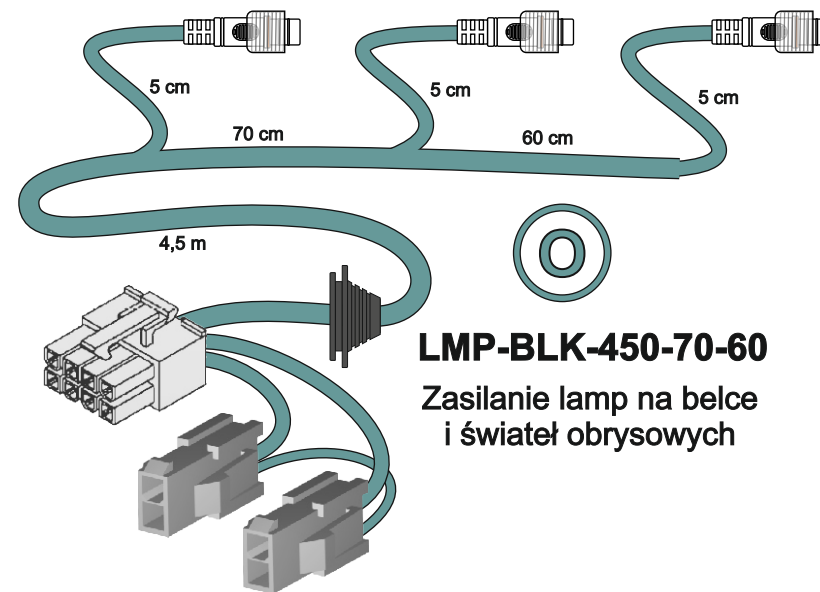

LMP-BLK-450-70-60

Zasilanie lamp na belce
i świateł obrysowych

5 cm

70 cm

5 cm

60 cm

5 cm

4,5 m

O

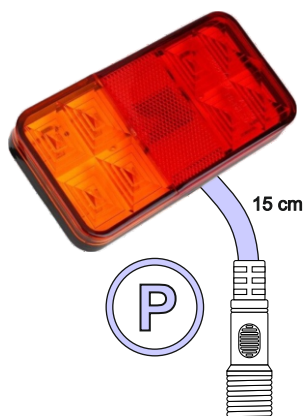

LMP-BLK-L-15
Lampa lewa na belce

15 cm

P

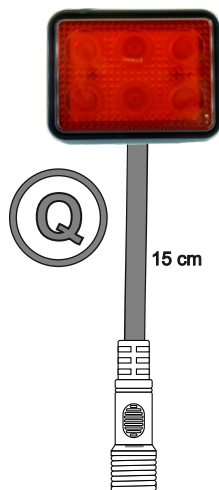

LMP-BLK-C-15
Lampa środkowa na belce

15 cm

Q

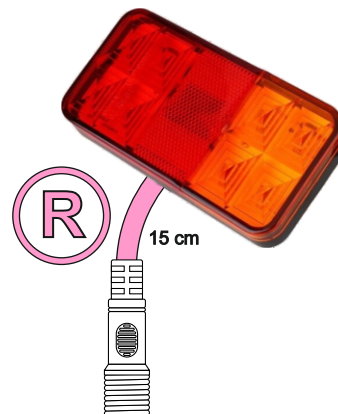

LMP-BLK-R-15
Lampa prawa na belce

15 cm

R

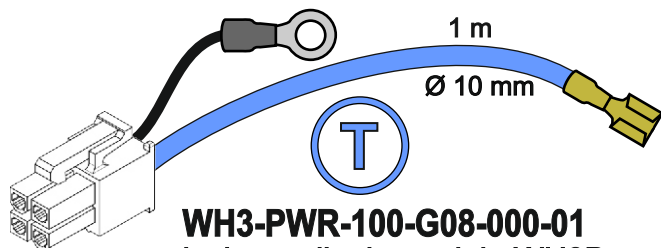

WH3-PWR-100-G08-000-01
wiązka zasilania modułu WH3B

1 m

Ø 10 mm

T

U

Bezpiecznik 5 A

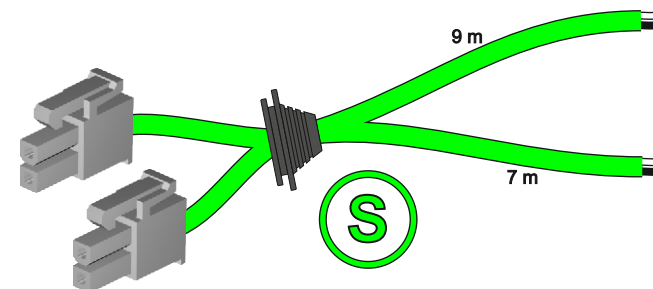

LMP-OBR-700-900
Zasilanie świateł obrysowych

9 m

7 m

S



WH3B